

PR6 and PR7

Wiring Elster's Inductive Output Pulsers.



WIRING PR6 AND PR7

What PR6 and PR7 are used for

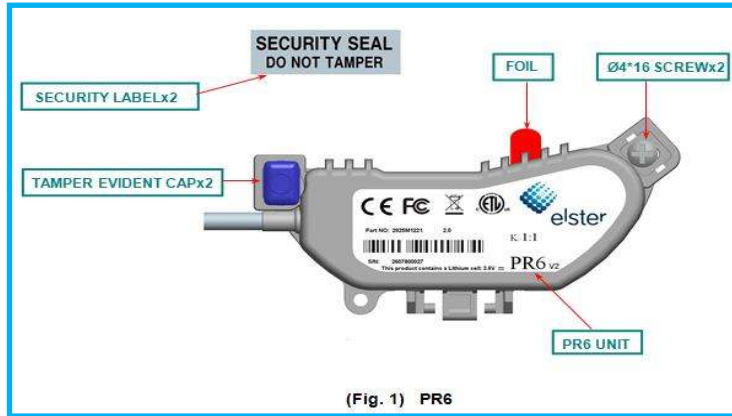

1. Elster PR6 inductive pulse unit.

Its fitted to the **V200/V210/V220**

and the **H4000P** series of meters



Remember to remove the foil tab before fitting the pulse unit to the meter!

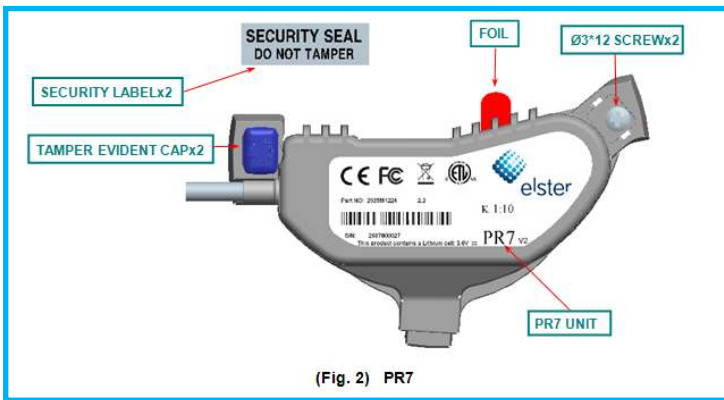

2. Elster PR7 inductive pulse unit.

Its fitted to the **H4000,C4000 and S2000** series of inductive output meters



WIRING PR6 AND PR7

What each wire does



K: 1:1

The **yellow** wire is the primary pulse output and labelled Channel 1 Pulse (CH1P)

The K factor of this pulse output is the first number after the 'K' on the PR6/PR7 label (see page 7 for pulse value calculation)

CH1P outputs all pulses regardless of direction, whether the meter is running backwards or forwards.

The **white** wire labelled Channel 1 Direction (CH1D) gives the direction of the pulses on CH1P. The signal is High for Forward Flow and Low for Reverse Flow

WIRING PR6 AND PR7

What each wire does



K: 1:1

The **red** wire is the secondary pulse output and labelled Channel 2 Pulse (CH2P)

The K factor of this output is the second number after the 'K' on the PR6/PR7 label (see page 7 for pulse value calculation)

CH2P outputs pulses that are compensated for backwards flow. The PR6/7 counts the backwards flow and stops outputting until the same forward flow has occurred.

The **green** wire labelled Channel 2 Compensation (CH2C) indicates when compensation is occurring by going to Low state during backflow compensation.

WIRING PR6 AND PR7

What each wire does



The **brown** wire is the alarm output and labelled Tamper (TAMP)
It activates to High state when the PR6/7 is removed from the meter.
It also activates to High state if the PR6/7 battery is low.

The **black** wire is the common or 0v wire and labelled Ground (GND)

WIRING PR6 AND PR7

Pulse outputs – Primary or Secondary

The PR6/7 is suitable for use with most data loggers, radio end points and counters. All outputs are open collector.

- Use the Secondary (**Red**) CH2P compensated output for general data logging, remote displays, or AMR equipment.
- Use the Primary (**Yellow**) CH1P output where reverse flow monitoring is required. Most data loggers support bidirectional monitoring. However it's best to check with the data logger supplier before buying.

For applications such as SCADA, BMS, PLC, the outputs may be connected via pull-up resistor to up to 30V. Maximum sink current is 30mA.

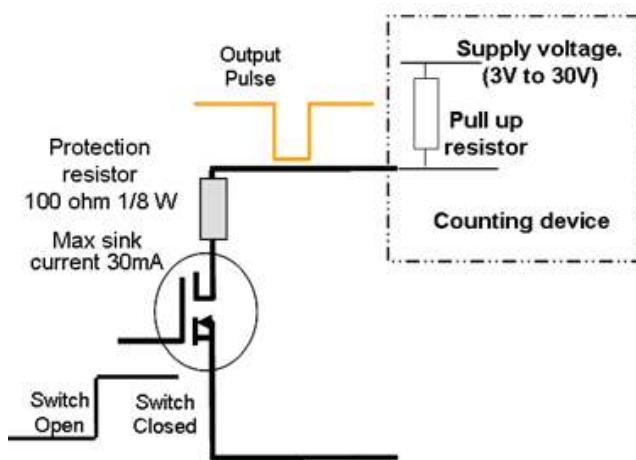

Fig1. PR6/7 Pulse output schematic

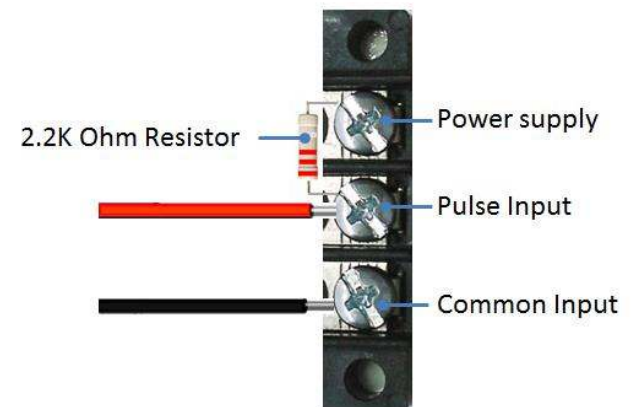

Fig 2. Wiring layout showing CH2P connected to PLC

WIRING PR6 AND PR7

Connecting to Waveflow TRC600 Meter Interface Unit (MIU)

- Connect the Secondary **Red** CH2P compensated output of the PR7 to the **Yellow** Pulse Input A of the TRC600
- Connect the **Brown** TAMP to the **Red** Wirecut A of the TRC600
- Connect the **Black** GND to the **Black** Ground of the TRC600

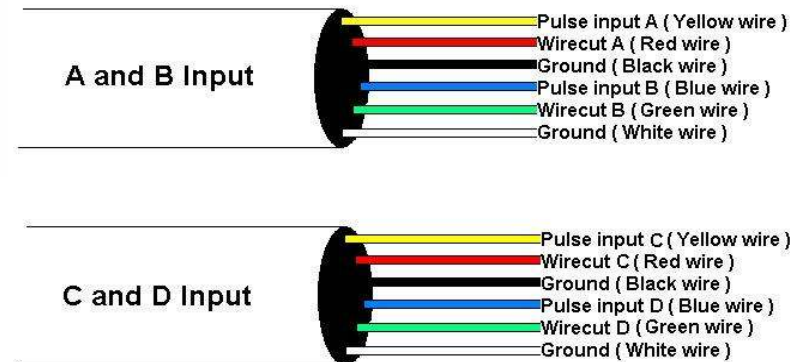
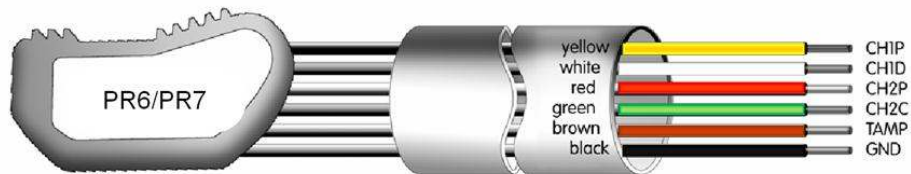
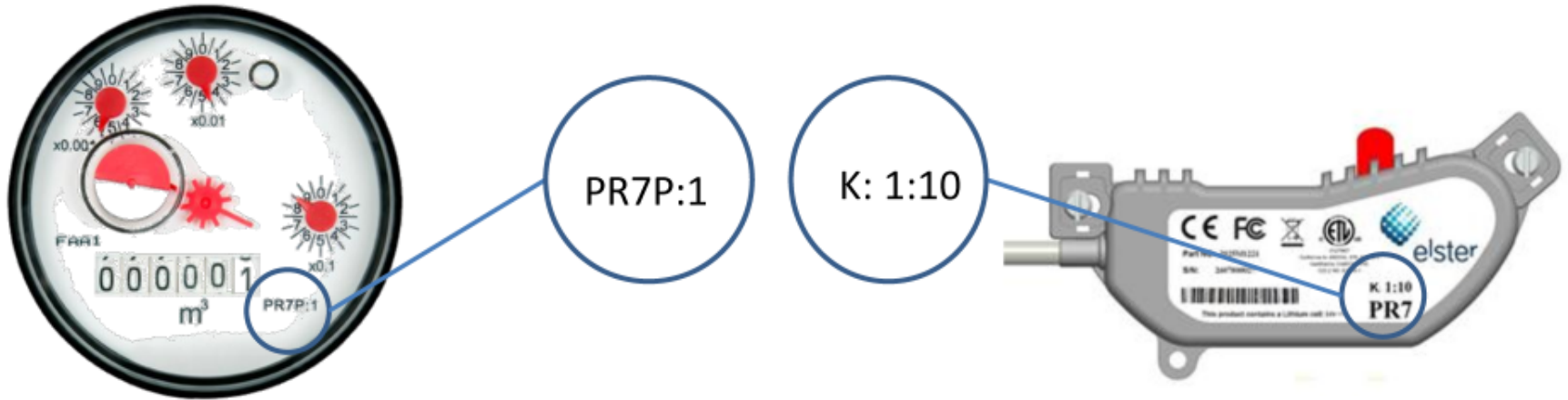

Fig1. PR6/7 Pulse output schematic

Fig 2. Waveflow MIU Input Wiring

WIRING PR6 AND PR7

K Factor – Calculating the pulse value



The pulse value (weight) is calculated by multiplying the Pulse Value P from the meter dial face by the K Value from the PR6/7 pulser label.

In the example above;-

For the Primary Pulse Output **Yellow** CH1P the pulse weight = $1 \times 1 = 1$ litre per pulse

For the Secondary Pulse Output **Red** CHP2 the pulse weight = $1 \times 10 = 10$ litres per pulse.

WIRING PR6 AND PR7

Pulser types, K Factors and example pulse values

Type	K Factor	Elster Part Number	Register Type	Primary Pulse Value	Secondary Pulse Value
PR6	1:1	2925M1221	PR6P:1	1 litre/pulse	1 litre/pulse
PR6	1:10	2925M1265	PR6P:1	1 litre/pulse	10 litres/pulse
PR6	1:100	2925M1261	PR6P:1	1 litre/pulse	100 litres/pulse
PR6	1:1000	2925M1262	PR6P:1	1 litre/pulse	1000 litres/pulse
PR7	10:10	2925M1222	PR7P:1	10 litres/pulse	10 litres/pulse
PR7	10:100	2925M1280	PR7P:10	100 litres/pulse	1000 litres/pulse
PR7	1:-	2925M1223	PR7P:10	10 litres/pulse	n/a
PR7	1:10	2925M1224	PR7P:10	10 litres/pulse	100 litres/pulse
PR7	1:100	2925M1263	PR7P:10	10 litres/pulse	1000 litres/pulse
PR7	1:1000	2925M1264	PR7P:1	1 litre/pulse	1000 litres/pulse

Pulse widths (milliseconds) PR6 K:1 = 80, PR7 K:1 = 10, all other PR6/7 = 100.